

Who is **SUNWAYFOTO**?

SUNWAYFOTO focuses on camera support system and specially provides professional and high-end tripod heads, quick-release system and panorama accessories. Established in 2008, SUNWAYFOTO dedicates itself in designing & producing high-end professional photographic equipment of original stylish design and top quality. SUNWAYFOTO has a dedicated research and development department, design team, professional CNC machine plant and self-owned anodizing factory so as to meet the strictest quality controls. SUNWAYFOTO pays great attention to user experience and maintains communication with end-users. Many design ideas and product improvements comes from our clients and pro photographers who are amongst our customers.

SUNWAYFOTO Target:

Supply top quality and user friendly photographic accessories to pro photographers / serious amateurs.

SUNWAYFOTO Vision:

To become one of the leading World Class Photographic Equipment Brands.

SUNWAYFOTO Concepts

Pursuit of optimal and specialized quality
 Persist in Originality and Innovation
 Keep Communicating and sharing

SUNWAYFOTO Products

Precision – Stability – Security – Stylish – Lifetime Warranty

All of the products are precisely CNC machined and Type III hard anodizing finished. The material is high quality aircraft magnesium-aluminum alloy, light and stunning. All of the quick release system is Arca-Swiss compatible. Specific design of safety screws and strap handles are applied to ensure security to all of the products. SUNWAYFOTO is selling more than equipment itself. We are providing precision, stability, security, stylish and lifetime warranty. You can place trust in a SUNWAYFOTO product when you take a photograph. You will be proud to own a SUNWAYFOTO product. Here at Sunwayfoto, we are an open-minded company, a company that listens to its customers suggestions, a company that takes criticism seriously, a company that is constantly looking for improvement so that we may evolve and improve.

Product Menu

- ✧ Tripod Head
 - XB Low Profile High Locking Strength Ball Head
 - FB Classic Single Notch Ball Head
 - Monopod Two-Way Head
- ✧ Quick-Release System
 - Specific QR Plate / L Bracket
 - Universal QR Plate / L Bracket
 - Universal Quick-Release Clamp
 - Specific QR Clamp
- ✧ Lens Accessory
 - Lens Replacement Foot
 - Focusing Handle
 - Lens Plate
- ✧ Panorama
 - Pano Head
 - Indexing Rotator
 - Leveling Base
 - Nodal Slider
 - Multi-Purpose Rail

XB Series Low Profile Ballhead



Photography by Radomir Jakubowski
<http://www.naturfotocamp.de>

Tripod Ball Head

SUNWAYFOTO Tripod Ball Head includes XB Series Low Profile Ball Head and FB Series Single Notch Ball Head, features all metal design (aviation magnesium-aluminum alloy), precise CNC machined, hard anodizing surface finished, laser engraved.

What makes SUNWAYFOTO tripod ball head outstanding is its superior locking strength, an ellipsoidal ball for off-centre loads and a choice of ARCA-Swiss Compatible clamps to complement the head.

Locking System

SUNWAYFOTO ball head utilizes unique Ellipsoidal Ball structure in its locking system to improve the operation stability and assure the reliable load capacity.

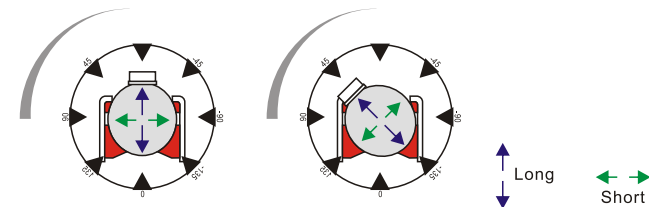

As a result of the diameters difference in x-axis and y-axis, the ball receives a progressive pressure from the locking system to balance the tilting torque.

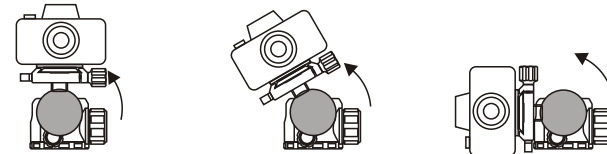

When orient the ball to find the preferred camera position, the gravity center of the camera moves and produces a torque. In this specific locking system, even at large tilt angle, the ball head is still able to make it lockable quickly and firmly.

Friction System

Friction System provides tension on the ball to hold the camera equipment after optimal adjustment, allows smooth movement, and prevent the camera from suddenly falling off when the main locking knob is loosened.

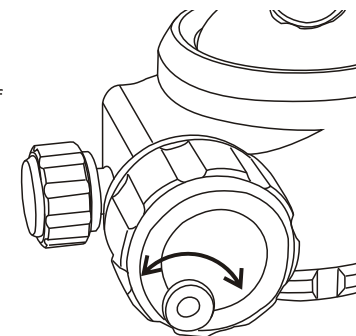
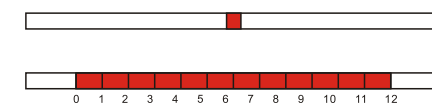

Vibration Dissipation

SUNWAYFOTO tripod ball head has a specific inner structure for vibration absorption. The lubrication also helps to absorb the vibration caused by camera or tripod.

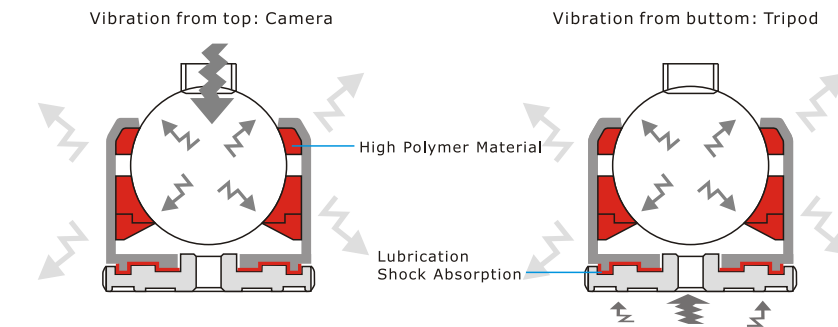

XB Series' Low Profile Structure

The ball locking system and pan base locking system compact in the originally designed inner structure so as to lower the gravity center of the head, improve the operation stability and make the ball perform more smoothly and firmly.

FB Series' Single Notch

Easy to operate with single notch. Specific light weight structure makes FB series ball head the lightest one among the same or similar ball diameter of other brands in the market. FB series ball head also perform outstandingly in aspect of ball and base locking. FB series ball head is a superior must-have for traveling photography.

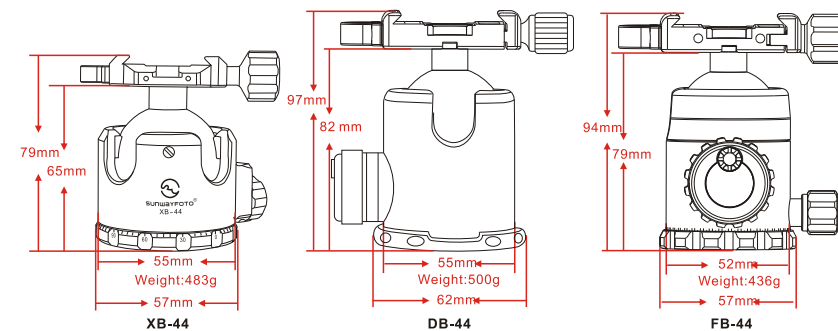

XB Series Low Profile Ballhead

Original Designed Low Profile Structure
 High strength of locking
 Ellipsoidal Ball for Off-Center Loads
 Arca-Swiss Compatible
 Patent Pending



SUNWAYFOTO®



XB-44

| | |
|---------------------|---------|
| ⌀ Diameter | 44mm |
| ⌀ Pan Base Diameter | 58mm |
| H Height | 79mm |
| ⚖ Weight | 483g |
| 📏 Max Load | 40kg |
| 🌀 Bottom thread | UNC3/8" |



XB-44DDH2

| | |
|---------------------|---------|
| ⌀ Diameter | 44mm |
| ⌀ Pan Base Diameter | 58mm |
| H Height | 82mm |
| ⚖ Weight | 470g |
| 📏 Max Load | 40kg |
| 🌀 Bottom thread | UNC3/8" |



XB-44DL

| | |
|---------------------|---------|
| ⌀ Diameter | 44mm |
| ⌀ Pan Base Diameter | 58mm |
| H Height | 79mm |
| ⚖ Weight | 490g |
| 📏 Max Load | 40kg |
| 🌀 Bottom thread | UNC3/8" |



XB-52

| | |
|---------------------|---------|
| ⌀ Diameter | 52mm |
| ⌀ Pan Base Diameter | 68mm |
| H Height | 91mm |
| ⚖ Weight | 685g |
| 📏 Max Load | 60kg |
| 🌀 Bottom thread | UNC3/8" |



XB-52DDH3

| | |
|---------------------|---------|
| ⌀ Diameter | 52mm |
| ⌀ Pan Base Diameter | 68mm |
| H Height | 102mm |
| ⚖ Weight | 839g |
| 📏 Max Load | 60kg |
| 🌀 Bottom thread | UNC3/8" |



XB-52DL

| | |
|---------------------|---------|
| ⌀ Diameter | 52mm |
| ⌀ Pan Base Diameter | 68mm |
| H Height | 91mm |
| ⚖ Weight | 685g |
| 📏 Max Load | 60kg |
| 🌀 Bottom thread | UNC3/8" |

XB Series Low Profile Ballhead



Photography by Leo Meier



FB Series Classic Ballhead

- ◎ Single Drop Notch
- ◎ Offset Bubble Level
- ◎ Light Weight Design
- ◎ High Locking Strength



FB-36

| | |
|---------------------|------------|
| ⌀ Diameter | 36mm |
| ⌀ Pan Base Diameter | 48mm |
| H Height | 83mm |
| 📖 Weight | 304g |
| 📖 Max Load | 18kg |
| 📍 Mounting Hole | UNC3/8"-16 |



FB-36DDH2

| | |
|---------------------|------------|
| ⌀ Diameter | 36mm |
| ⌀ Pan Base Diameter | 48mm |
| H Height | 82mm |
| 📖 Weight | 325g |
| 📖 Max Load | 18kg |
| 📍 Mounting Hole | UNC3/8"-16 |



FB-36DL

| | |
|---------------------|------------|
| ⌀ Diameter | 36mm |
| ⌀ Pan Base Diameter | 48mm |
| H Height | 83mm |
| 📖 Weight | 320g |
| 📖 Max Load | 18kg |
| 📍 Mounting Hole | UNC3/8"-16 |

FB Series Classic Ballhead



FB-44

| | |
|---------------------|------------|
| ⌀ Diameter | 44mm |
| ⌀ Pan Base Diameter | 55mm |
| H Height | 94mm |
| 📖 Weight | 436g |
| 📖 Max Load | 30kg |
| 📍 Mounting Hole | UNC3/8"-16 |



FB-44DDH2

| | |
|---------------------|------------|
| ⌀ Diameter | 44mm |
| ⌀ Pan Base Diameter | 55mm |
| H Height | 97mm |
| 📖 Weight | 450g |
| 📖 Max Load | 30kg |
| 📍 Mounting Hole | UNC3/8"-16 |



FB-44DL

| | |
|---------------------|------------|
| ⌀ Diameter | 44mm |
| ⌀ Pan Base Diameter | 55mm |
| H Height | 93mm |
| 📖 Weight | 470g |
| 📖 Max Load | 30kg |
| 📍 Mounting Hole | UNC3/8"-16 |



Two-Way Head



SUNWAYFOTO®



Monopod Head DT-01D50

| | |
|---------------|---------|
| Base Diameter | 40mm |
| Height | 85mm |
| Weight | 355g |
| Max Load | 12kg |
| Bottom thread | UNC3/8" |



Long Lens Head DT-02D50

| | |
|-------------------|---------|
| Pan Base Diameter | 54mm |
| Height | 103mm |
| Weight | 448g |
| Max Load | 12kg |
| Bottom thread | UNC3/8" |

Quick-Release System

Arca-Swiss Compatible



Photography by Sandra Bartocha

- Specific QR Plate / L Bracket
- Universal Quick-Release Plate / L Bracket
- Universal Quick-Release Clamp
- Specific Quick-R Clamp

PC-5DIII

Specific QR Plate for Canon 5D Mark III (without Battery Grip)



| | | |
|--|-----------------|------------|
| | Length | 64mm |
| | Thickness | 13mm |
| | Weight | 40g |
| | Width | 52mm |
| | Mounting Thread | UNC1/4"-20 |



PCL-5DIII

Specific L-Bracket for Canon 5DIII (without battery grip)



| | | |
|--|---------------|------------|
| | Length | 114mm |
| | Width | 52mm |
| | Height | 84mm |
| | Mounting Hole | UNC1/4"-20 |
| | Weight | 102g |



For Canon 5D Mark II

PC-5DII

Specific QR Plate for Canon 5D Mark II (without Battery Grip)



| | | |
|--|-----------------|------------|
| | Length | 49.6mm |
| | Thickness | 11.5mm |
| | Width | 49mm |
| | Weight | 34g |
| | Mounting Thread | UNC1/4"-20 |



For Nikon D3 Camera



PN-D3N
Specific QR Plate for Nikon D3 Camera



| | |
|-----------------|------------|
| Length | 79mm |
| Thickness | 15mm |
| Width | 70mm |
| Weight | 50g |
| Mounting Thread | UNC1/4"-20 |

PN-D4
Specific QR Plate For Nikon D4



| | |
|---|------------|
| Length | 79mm |
| Thickness | 15mm |
| Width | 70mm |
| Weight | 51g |
| Mounting Thread | UNC1/4"-20 |
| Total Length between the two mounting holes | 18mm |



PNL-D4
Specific L-Bracket for Nikon D4

| | |
|-----------------|------------|
| Length | 87mm&122mm |
| Width | 71.5mm |
| Height | 78mm&126mm |
| Mounting Thread | UNC1/4"-20 |
| Weight | 133g |



For Nikon

D800/D700 SPECIFIC PLATE



PNL-D800
Specific L-Bracket for Nikon D800/D
(without battery grip)

| | |
|-----------------|------------|
| Length | 114.5mm |
| Weight | 82g |
| Width | 60.5mm |
| Height | 83.5mm |
| Mounting Thread | UNC1/4"-20 |



PN-D800
Specific QR Plate For Nikon D800/D800E

| | |
|-----------------|------------|
| Length | 60mm |
| Thickness | 13mm |
| Width | 55mm |
| Weight | 38g |
| Mounting Thread | UNC1/4"-20 |



PN-D700
Specific QR Plate For Nikon D700

| | |
|-----------------|------------|
| Length | 64mm |
| Thickness | 13mm |
| Width | 48mm |
| Weight | 37g |
| Mounting Thread | UNC1/4"-20 |

For SONY

N7 SPECIFIC PLATE



PSL-N7
Specific 2 in 1 L-Bracket for Sony NEX-7

| | |
|-----------------|------------|
| Length | 82mm |
| Height | 54.5mm |
| Width | 40mm |
| Weight | 32g |
| Mounting Thread | UNC1/4"-20 |



PS-N7
Specific QR Plate for Sony Nex-7

| | |
|-----------------|------------|
| Length | 82mm |
| Thickness | 8mm |
| Width | 40mm |
| Weight | 24g |
| Mounting Thread | UNC1/4"-20 |
| Mounting Size | 39mm*39mm |

For SONY

N5 SPECIFIC PLATE



PS-N5

Specific QR Plate for Sony Nex-5

| | |
|-----------------|------------|
| Length | 56mm |
| Thickness | 16mm |
| Width | 39mm |
| Weight | 27g |
| Mounting Thread | UNC1/4"-20 |



PS-N5



PS-N5R



PS-N5Y

Universal Quick-Release Plate



DP-26: For small sized cameras, Interchangeable Lens Digital Cameras
DP-39: For small-sized film and DSLR cameras, with rubber pad and without flange.
DPG-39: For Instamatics or small-sized film and DSLR cameras, suit for OLYMPUS 0M20, NikonD80,D90,Cannon 550D,600D, etc.
DPG-50: For Canon 5DII without battery grip, 5D,7D,and the cameras with bottom width of about 50mm.
DPG-50U: For Nikon D200/D300/D700, Cannon 50D,5D,5DII,7D,1D and 1DS series.
DPG-70: For Canon 1D series, Nikon D3 series, and cameras with wide battery grip base

| MODEL | Length | Thickness | Width | Weight | Mounting Thread |
|----------------|--------|-----------|-------|--------|-----------------|
| DP-26 | 26mm | 7.5mm | 39mm | 9g | UNC1/4"-20 |
| DP-39 | 45mm | 10mm | 39mm | 30g | UNC1/4"-20 |
| DPG-39 | 45mm | 10/12.5mm | 39mm | 30g | UNC1/4"-20 |
| DPG-50 | 56mm | 10/13mm | 50mm | 43g | UNC1/4"-20 |
| DPG-50U | 56mm | 10/13mm | 50mm | 43g | UNC1/4"-20 |
| DPG-70 | 80mm | 10/14.5mm | 70mm | 87g | UNC1/4"-20 |

For Middle & Large Format Cameras



| MODEL | Length | Thickness | Groove length | Width | Weight | Mounting Thread |
|---------------|--------|-----------|---------------|-------|--------|------------------------|
| DP-60 | 60mm | 10mm | 28mm | 39mm | 50g | UNC1/4"-20&UNC 3/8"-16 |
| DP-508 | 80mm | 10mm | 54mm | 50mm | 62g | UNC1/4"-20&UNC 3/8"-16 |
| DP-610 | 100mm | 10mm | 74mm | 80mm | 90g | UNC1/4"-20&UNC 3/8"-16 |
| DP-813 | 130mm | 10mm | 104mm | 80mm | 151g | UNC1/4"-20&UNC 3/8"-16 |

Universal Q-R L Plate

- DPL-01 For cameras without grip with cord
- DPL-02 For cameras without battery grip nor remote cord
- DPL-03 For cameras without grip with cord, with flip screen because the flange is able to remove to fit the flip screen
- DPL-04 For cameras without grip with cord but for cameras with wider base
- DPL-05 For cameras with grip without remote cord, without flip screen



Universal L Bracket

| Model | Length | Weight | Width | Setting Range | Mounting Thread |
|--------|-----------|--------|-------|---------------|-----------------|
| DPL-01 | 80/110mm | 75g | 39mm | 40mm-76mm | UNC1/4"-20 |
| DPL-02 | 80/110mm | 91g | 39mm | 41mm-63mm | UNC1/4"-20 |
| DPL-03 | 80/110mm | 80g | 39mm | 40mm-76mm | UNC1/4"-20 |
| DPL-04 | 80/110mm | 90g | 39mm | 40mm-76mm | UNC1/4"-20 |
| DPL-05 | 104/120mm | 160g | 41mm | 58mm-82mm | UNC1/4"-20 |

Quick-Release Clamp



Screw-Knob Clamp

| MODEL | Jaw Length | Thickness | Width | Weight | Mounting Thread |
|--------|------------|-----------|-------|--------|-----------------|
| DDC-42 | 42mm | 15mm | 95mm | 95g | UNC1/4"-20 |
| DDC-50 | 50mm | 15mm | 95mm | 105g | UNC3/8"-16 |
| DDC-60 | 60mm | 15mm | 95mm | 120g | UNC3/8"-16 |

Lever-Release Clamp

| MODEL | Jaw Length | Thickness | Width | Weight | Mounting Thread |
|----------|------------|-----------|-------|--------|-----------------|
| DDC-42LR | 42mm | 15mm | 85mm | 86g | UNC1/4"-20 |
| DDC-50LR | 50mm | 15mm | 85mm | 99g | UNC3/8"-16 |
| DDC-60LR | 60mm | 15mm | 85mm | 113g | UNC3/8"-16 |

Knob/Lever Combo Clamp

| MODEL | Jaw Length | Thickness | Width | Weight | Mounting Thread |
|--------|------------|-----------|-------|--------|-----------------|
| DLC-42 | 42mm | 15mm | 87mm | 88g | UNC1/4"-20 |
| DLC-50 | 50mm | 15mm | 87mm | 99g | UNC3/8"-16 |
| DLC-60 | 55mm | 15mm | 60mm | 127g | UNC3/8"-16 |

Panning Clamp

| MODEL | Top Diameter | Base Diameter | Height | Weight | Mounting Hole |
|--------|--------------|---------------|--------|--------|---------------|
| DDH-02 | 51mm | 52mm | 9.5mm | 70g | UNC3/8"-16 |
| DDH-03 | 58mm | 57mm | 26mm | 126g | UNC3/8"-16 |



Discal Clamp

| MODEL | Whole Length | Thickness | Diameter | Weight | Mounting Hole |
|----------------|--------------|-----------|----------|--------|---------------|
| DDY-64i | 81mm | 15.5mm | 64mm | 80g | UNC3/8"-16 |
| DDY-58 | 75mm | 15.5mm | 58mm | 60g | UNC3/8"-16 |

DDB-53 Bidirectional Clamp



| | | | |
|-----------------|------------|-----------|------|
| Jaw Length | 54.5mm | Thickness | 27mm |
| Width | 53mm | Weight | 214g |
| Mounting Thread | UNC3/8"-16 | | |

MCP-01



| | | | |
|------------------------|-------|-----------|------|
| Length | 36mm | Thickness | 32mm |
| Width | 110mm | Weight | 130g |
| One 1/4 Flathead Screw | | | |

DDT-53 Subtend Clamp



| | | | |
|-----------------|------------|-----------|------|
| Jaw Length | 54.5mm | Thickness | 21mm |
| Width | 53mm | Weight | 158g |
| Mounting Thread | UNC3/8"-16 | | |

DDC-G1 Specific Clamp For Gitzo Traveler Tripod Head



| | | | |
|--------|------|-----------|------|
| Length | 95mm | Thickness | 15mm |
| Width | 53mm | Weight | 100g |



- Lens Replacement Foot
- Focusing Handle
- Lens Plate

Lens Accessory

Lens Accessory

Long Lens Replacement Foot



Features:
 Arca-Swiss Foot Built-in
 Two-Mounting-Screw Design for Safety & Stability
 Each Foot Fits MORE THAN ONE model of Lenses



LF-C1 For Canon
 Canon 400mm F2.8 IS/ISII
 Canon 600mm F4 IS/ISII
 Canon 800mm F5.6 IS



LF-C2 For Canon
 Canon 400mm F2.8 IS/ISII
 Canon 600mm F4 IS/ISII
 Canon 800mm F5.6 IS



LF-N1 For Nikon
 Nikon 300mm F2.8 VR/VR II
 Nikon 500mm F4 VR
 Nikon 200-400mm F4 VR / VR II
 Nikon AF-S 400mm/f2.8-ED-IF (version I & II)
 Nikon AF-S 400mm/f2.8-ED-IF VR
 Nikon AF-S 400mm/f2.8-ED-IF VR-II
 Nikon AF-S 600mm/f4D-ED-IF
 Nikon AF-S 600mm/f4G ED VR
 Nikon AF-S 600mm/f4G ED VR-II



LF-N2 For Nikon
 Nikon AFS200/2VR
 Nikon AF200/2VR II

Lens Accessory

Focusing Handle



Patent Pending







| Model | Inner Size | Handle Length | Weight |
|---------------|------------|---------------|--------|
| DRH-60 | 58mm-66mm | 46mm | 40g |
| DRH-65 | 63mm-71mm | 46mm | 43g |
| DRH-70 | 68mm-76mm | 46mm | 48g |
| DRH-77 | 75mm-83mm | 46mm | 48g |
| DRH-88 | 86mm-92mm | 46mm | 65g |

Originally designed Focusing Handles perform well to zoom precisely, providing a simple way for smooth and accurate focusing adjustment when shooting.

Lens Accessory

Telephoto lens support

- Provide extra stability to support the lens.
- Easy to adjust the stretch length and support height to balance the camera and lens.
- Versatile Structure, Various Combo Set with Rails and Clamps.

| | |
|--|---------------|
|  Clamp Mounting Screw | UNC1/4"-20 |
|  Lens Support Mounting Screw | UNC1/4"-20 |
|  Camera Max Ceiling Height | 68mm |
|  Weight | 290g |
|  Max Length(Camera Mount Center to Lens Support Mount Center) | 270mm |
|  Package Size | 140L*110W*95H |



Combo Set:

- 1 * TLS-01
- 1 * DPG-3016
- 1 * DDC-50



TLS-01



Lens Accessory

Universal Lens Plate



DPG-62

For 70mm or 80mm to 200mm zoom lenses or any lens with a mounting foot of up to 56mm.







| | | | |
|---|------------|---|------|
|  Length | 62mm |  Groove length | 29mm |
|  Width | 39mm |  Weight | 40g |
|  Mounting Thread | UNC1/4"-20 | | |

DPG-76

For 70mm or 80mm to 200mm zoom lenses or any lens with a mounting foot of up to 70mm.



| | | | |
|---|------------|---|------|
|  Length | 76mm |  Groove length | 43mm |
|  Width | 39mm |  Weight | 45g |
|  Mounting Thread | UNC1/4"-20 | | |

DPG-80D

Double Dovetail
For long lens as Nikon AFS70-200/2.8; AFS300/2.8







| | | | |
|---|------------|---|------|
|  Length | 80mm |  Groove Length | 47mm |
|  Width | 39mm |  Weight | 50g |
|  Mounting Thread | UNC1/4"-20 | | |

DPG-120D

Double Dovetail
For long lens as 300/2.8



| | | | |
|---|------------|---|------|
|  Length | 120mm |  Groove Length | 87mm |
|  Width | 39mm |  Weight | 70g |
|  Mounting Thread | UNC1/4"-20 | | |



Photography by Leo Meier

Panorama

- Pano Head
- Indexing Rotator
- Leveling Base
- Nodal Slider
- Multi-Purpose Rail



Photography by Benjamin Sommer



Pano Head

Integrated components perform well in panoramic operation. Users can assemble these integral parts easily and freely, according to different photography requirement.

Pano Head Components:

- **Leveling Base:** DYH-66i / DYH-90
- **Indexing Rotator:** DDP-64M / DDP-64S
- **Discal Clamp:** DDY-64i / DDY-64L
- **Multi-Purpose Rail:** DPG-2416 / DPG-3016 / DPG-210
- **Nodal Slider (with vertical clamp):** DMC-200 / DMC-200L
- **Panning Clam Combop:** DDH-03 & DDY-58
- **Nodal Slider (with Horizontal clamp):** DMP-200 / DMP-200L / DMP-100 / DMP-140
- **L Bracket:** DPL-01 / DPL-02 / DPL-03 / DPL-04 / DPL-05

Indexing Rotator



DDP-64M

Two Locking Knobs for Panning Top and Panning Base.
Laser Engraved Index Marks 0°-360°.
10 kinds of Detent Setting.
Degree Increments from 5° to 90°.

- 5° - 72 stops
- 10° - 36 stops
- 15° - 24 stops
- 20° - 18 stops
- 24° - 15 stops
- 30° - 12 stops
- 36° - 10 stops
- 45° - 8 stops
- 60° - 6 stops
- 90° - 4 stops



DDP-64S

Single Locking Knob for panning base
Laser Engraved Index Marks 0°-360°
4 kinds of Detent Setting.
Degree Increments from 8° to 18°.

- 8° - 45 stops
- 12° - 30 stops
- 15° - 24 stops
- 18° - 20 stops

| MODEL | Base Diameter | Height | Bottom Thread | Mounting Screw | Max Load | Weight |
|----------------|---------------|--------|---------------|----------------|----------|--------|
| DDP-64M | 64mm | 46mm | UNC3/8"-16 | UNC1/4"-20 | 10kg | 400g |
| DDP-64S | 64mm | 26mm | UNC3/8"-16 | UNC1/4"-20 | 6-8kg | 210g |

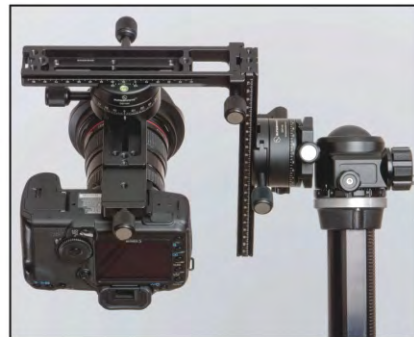
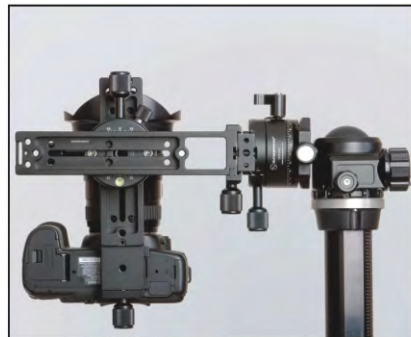
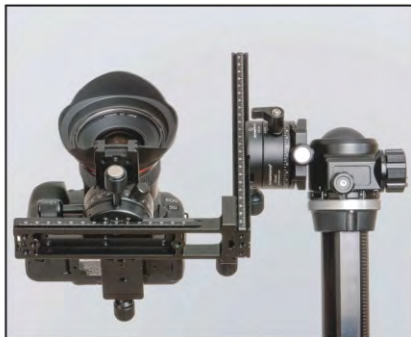

photography by Leo Meier

Leveling Base



DYH-66i

- 66mm Levelling Base
- For Small-Size Cameras
- Outstretched Spirit Level
- Improved Locking System
- Adjustment Range: ±16°



DYH-120

- 120mm Levelling Base
- For Heavy and Video Cameras
- For 8x10, 11x14, 16x20 Large Format Cameras
- Improved Locking System
- Adjustment Range: ±17°



DYH-120TRO

| MODEL | Platform Diameter | Base Diameter | Height | Weight | Mounting Screw | Bottom Thread |
|-------------------|-------------------|---------------|--------|--------|----------------|---------------|
| DYH-66i | 66mm | 60mm | 45mm | 295g | UNC1/4"-20 | UNC3/8"-16 |
| DYH-120 | 120mm | 86mm | 54mm | 810g | UNC3/8"-16 | UNC3/8"-16 |
| DYH-120TRO | 120mm | 86mm | 72mm | 992g | — | UNC3/8"-16 |

Leveling Base



DYH-90A



DYH-90B



DYH-90



DYH-90R

DYH-90 Series

90mm Levelling Base
For 4x5, 5x7 and 8x10 Format Cameras
Outstretched Spirit Level
Improved Locking System
Adjustment Range: $\pm 17^\circ$

DYH-90: Basic Model, Offset Spirit Level
DYH-90R: with top panning platform, Offset Spirit Level
DYH-90A: with top panning platform, with fixed lever-release clamps
DYH-90B: without top panning platform, with fixed lever-release clamps

| MODEL | Platform Diameter | Base Diameter | Height | Bottom Thread | Max Load | Weight |
|---------|-------------------|---------------|--------|---------------|----------|--------|
| DYH-90 | 90mm | 76mm | 50mm | UNC3/8"-16 | 30kg | 455g |
| DYH-90A | 90mm | 76mm | 67mm | UNC3/8"-16 | 30kg | 654g |
| DYH-90B | 90mm | 76mm | 63mm | UNC3/8"-16 | 30kg | 527g |
| DYH-90R | 90mm | 76mm | 60mm | UNC3/8"-16 | 30kg | 642g |

Nodal Slider



DMP-100



DMP-140



DMC-200
Vertical Rail

Photography by Leo Meier



DMP-200



DMP-200L



DMC-200L
Vertical Rail

| MODEL | Plate Length | Width | Whole Length | Weight | Clamp Stype | Mounting Screw |
|----------|--------------|-------|--------------|--------|---------------|----------------|
| DMP-100 | 100mm | 39mm | 125mm | 115g | Screw-knob | UNC1/4"-20 |
| DMP-140 | 140mm | 39mm | 165mm | 110g | Screw-knob | UNC1/4"-20 |
| DMP-200 | 200mm | 39mm | 230mm | 193g | Screw-knob | UNC1/4"-20 |
| DMP-200L | 200mm | 39mm | 215mm | 190g | Lever-Release | UNC1/4"-20 |
| DMC-200 | 200mm | 39mm | 200mm | 173g | Screw-knob | UNC1/4"-20 |
| DMC-200L | 200mm | 39mm | 200mm | 200g | Lever-Release | UNC1/4"-20 |

Multi-Purpose Rail

Modular Design Idea



DPG-210

| | | | |
|-----------------|------------|-----------|------|
| Length | 200mm | Thickness | 10mm |
| Width | 39mm | Weight | 132g |
| Mounting Thread | UNC1/4"-20 | | |



DPG-2416

| | | | |
|-----------------|------------|-----------|------|
| Length | 240mm | Thickness | 16mm |
| Width | 39mm | Weight | 194g |
| Mounting Thread | UNC1/4"-20 | | |



DPG-3016

| | | | |
|-----------------|------------|-----------|------|
| Length | 300mm | Thickness | 16mm |
| Width | 39mm | Weight | 304g |
| Mounting Thread | UNC1/4"-20 | | |



Photography by Leo Meier



Stereo Kit:

Panning Clamp: DDH-02 / DDH-03
 Multi-Purpose Rail: DPG-2416 / DPG-3016 / DPG-210
 Subtend Clamp: DDT-53

Modular design idea is another SUNWAYFOTO feature. XB series ball head, FB series ball head and DT series two-way head are designed by modular idea, feature a choice of ARCA-Swiss Compatible clamps to complement the head.

I. Arca Mounting Plate:

AM-01 / AM-02

Arca Mounting Plate is a smart design to add the dovetail function to other products.



DDH-03 & AM-02



DDP-64SX (DDP-64S & AM-01)



DDP-64MX (DDP-64M & AM-01)

II. Discal Clamps:

DDY-58 / DDY-64 / DDY-64i / DDY-64L

Discal Clamp has 2 special M3 screw mounting holes, which is used to mount Discal Clamp to other products and add a function clamp.



DDY-64 & DDP-64S



DDY-64 & DDP-64M



DDY-64 & DYH-90

Testimonial

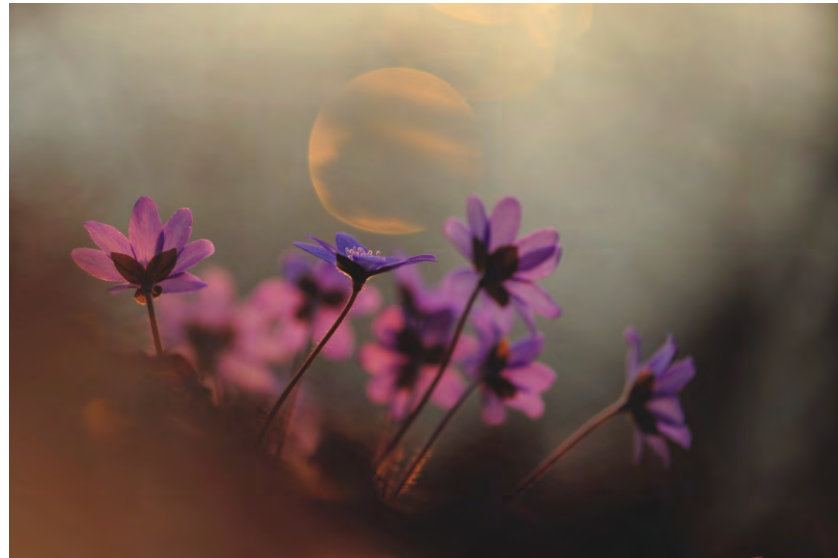

Photography by Sandra Bartocha

The great thing about the Superior Low-Profile Ballhead XB-44 is that it is incredibly sturdy and lightweight and the same time. With its super low base it lets me use it at a very low angle – perfect for flower and low-angle landscape photography.

Sandra Bartocha
Nature Photographer & Author

Out in the field, I have to rely on every piece of my equipment. The Sunway XB-52 Low-Profile Ballhead is a Ballhead I can fully rely on, no matter if I shoot wildlife or landscapes!"

Michael Lauer
Professional Photographer



Photography by Michael Lauer



Photography by Leo Meier

The Sunwayfoto XB-52 ballhead performed flawlessly in all conditions and it was a joy to use. I highly recommend it.

I was so impressed with the performance of the XB-52 ballhead in the field with all of the equipment and techniques I used (full frame 35mm DSLR bodies with lenses from 14mm to 400mm, shooting landscape, wildlife, macro, nocturnal macro flash, panorama stitching, HDR and focus stacking), that I decided to test it further in my studio, using a range of equipment. The XB-52 ballhead coped with all the challenges I put up against it with ease, even with outrageously extended and cantilevered configurations.

Leo Meier
Professional Photographer

It's really important for me to have my equipment working all over the world. The SUNWAYFOTO XB-52 does its job everywhere, that's why I like this ball head. The XB-52 is surprisingly light and works perfectly even with long and heavy lenses.

Radomir Jakubowski
Nature Photographer

Every person, country or even company, passes through the faces of infancy, adolescence and finally maturity. When it comes to an enterprise, its course is designated by the management and the people behind the brand name. Whose restlessness and creativity is reflected on the products and the pace of the company.

Sunwayfoto, although a relatively new company has passed from infancy to adolescence in a very fast pace, merging innovation with quality. By listening to photographers needs and comments, continuously improving the functionality and quality of their products, Sunwayfoto is heading into maturity and establishing their brand name in the higher segment of the photographic support equipment market, admirably fast.

Sotiris C. Vlachos
SCVPhotoIdeas.com